

**ADV38FR**  **READY**  
**10.2" OVERHEAD LCD**  
**MONITOR WITH**  
**DVD PLAYER**

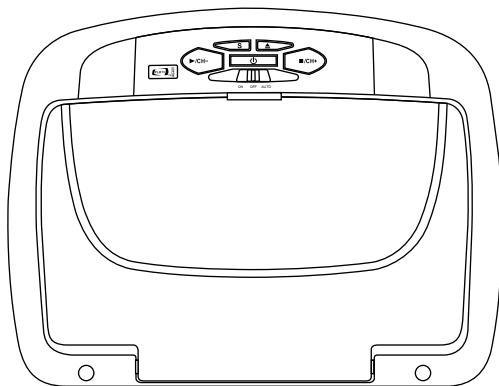

**///ADVENT®**

**OPERATION  
MANUAL**

128-8816



## Important Notice

Installation of overhead products requires careful planning and preparation. Be extremely careful when working on a vehicle with side curtain air bags. Do not route wires near any portion of the side curtain air bag assemblies. This includes any anchor points in A, B, C or D pillars of the vehicle. Routing wires in these areas or running wires by the side curtain air bags can prevent the side curtain air bag from fully deploying which can result in personal injury to vehicle occupants. If you have any questions regarding wire routing in a vehicle, please contact Audiovox Technical Support at 1-800-225-6074.

When connecting power and ground in a mobile video installation ensure that the ACC wire is fused at the point where it is connected to the vehicle ACC wiring. Failure to do so can result in damage to the vehicle if a short circuit develops between the vehicle connection point and the mobile video product.

An LCD panel and/or video monitor may be installed in a motor vehicle and visible to the driver if the LCD panel or video monitor is used for vehicle information, system control, rear or side observation or navigation. If the LCD panel or video monitor is used for television reception, video or DVD play, the LCD panel or video monitor must be installed so that these features will only function when the vehicle is in "park" or when the vehicle's parking brake is applied.

An LCD panel or video monitor used for television reception, video or DVD play that operates when the vehicle is in gear or when the parking brake is not applied must be installed to the rear of the driver's seat where it will not be visible, directly or indirectly, to the operator of the motor vehicle.

## Warnings

- Do not use any solvents or cleaning materials when cleaning the video monitor.
- Do not use any abrasive cleaners, they may scratch the screen.
- Use only a lightly dampened lint free cloth to wipe the screen if it is dirty.
- Lock the LCD screen in the fully closed position when not in use.
- Before putting on headphones always adjust the volume setting to the lowest position.
- Remember to leave the dome light switch in the off or auto positions when the vehicle is unattended, as the dome lights, if left on, can drain the vehicle's battery.
- Do not put pressure on the screen.
- Caution children to avoid touching or scratching the screen, as it may become dirty or damaged.

Licensed under one or more of the following patents,  
Patent NOS. 5,775,762 , 5,927,784 and 6,678,892

## Congratulations

Congratulations on your purchase of the ADVENT ADV38FR DVD Player with Drop-Down Video / Monitor. The ADV38FR has been designed to give you and your family many years of video entertainment in the mobile environment. Please read the directions that follow to familiarize yourself with the product to ensure that you obtain the best results from your equipment.

**Please note:** Installation options vary, see the individual owner's manuals for each component in your system to obtain a full understanding of each component's operation.

## Safety Precaution

For safety reasons, when changing video media it is recommended that the vehicle is not in motion, and that you do not allow children to unfasten seat-belts to change video media or make any adjustments to the system. System adjustments can be accomplished using the remote control, while seat-belts remain fastened. Enjoy your ADVENT entertainment system but remember the safety of all passengers remains the number one priority.

## FEATURES

- 10.2" TFT (Thin Film Transistor) Active Matrix LCD (Liquid Crystal Display) Monitor.
- Built-in DVD Player.
- OSD (On Screen Display) for Control of Picture Quality and Functions.
- Single Channel Infrared Transmitter for IR Wireless Headphones.
- Four Audio/Video Source Inputs (DVD/USB, AV1/FLO TV, AUX and GAME).
- Dome Lights with Built-in Three Way Switch.
- Built-in 16 Channel Wireless FM Modulator.
- Last Position Memory for DVD.
- Screen Mode Selection (4:3, 16:9).
- Wireless Game Controller.
- Full Function Remote Control.
- Backlit Controls.
- 1 AV Output via RCA Pigtail.
- Plays DVD, CD and MP3 Discs.
- FLO TV Ready.

## CONTROLS AND INDICATORS DIAGRAM (FRONT VIEW)

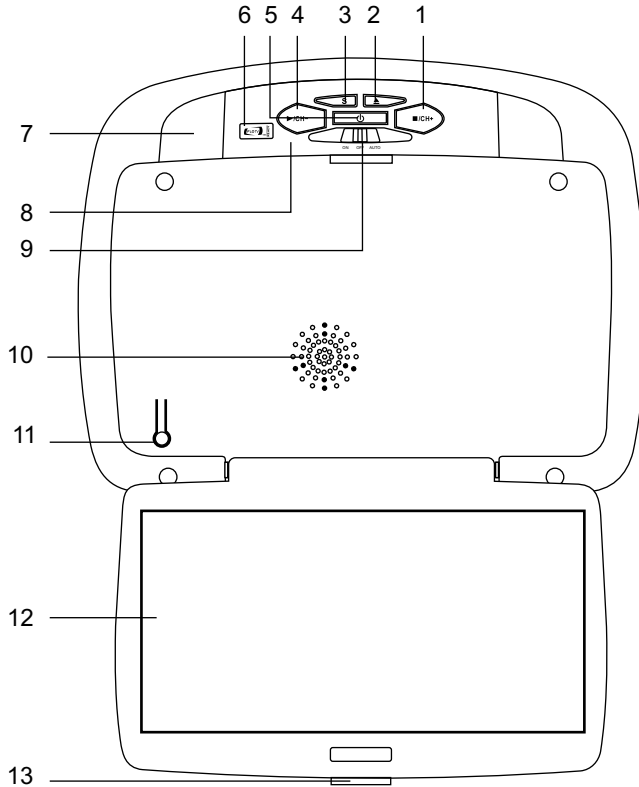

### 1. STOP (■) / CHANNEL UP (CH+) control

#### a.) STOP (■)

- Press the STOP button once : Stops playback. Pressing the PLAY button will resume playback from where the movie was stopped.
- Press the STOP button twice : Pressing the PLAY button will resume playback from the beginning of the DVD.

#### b.) CHANNEL UP (CH+)

Increases FLO TV channel number

**Note:** This control function control is available when the overhead unit is used with an optional plug in FLO TV Harness and FLO TV Module.

### 2. EJECT (▲) Control

This control is used for ejecting discs from the disc compartment. (**Note:** Disc can be ejected with the unit turned Off. Vehicle ignition must be in Run or ACC position). After the Disc is removed the unit will turn Off in 15-20 seconds.

### 3. Source Select

Use to select one of the four sources: DVD/USB, AV1/FLO TV, AUX and GAME

### 4. PLAY (▶) / CHANNEL DOWN (CH-) Control

#### a.) PLAY (▶)

This control is used to start playback of a disc.

#### b.) CHANNEL DOWN (CH-)

Decreases FLO TV channel number

**Note:** This control function control is available when the overhead unit is used with an optional plug in FLO TV Harness and FLO TV Module.

**5. POWER (⏻) Control**

Used to turn the system on/off.

**6. FLO TV Indicator**

The mode LED will change from white to purple when the FLO TV is connected.

**7. Dome Lights**

Provide additional interior illumination.

**8. Infrared Transmitter and Sensor**

Transmits audio to wireless headphones, allows the remote control to operate the ADV38FR and to control other accessories in the system.

**9. Three Position Dome Light Switch**

**ON** - Turns on the dome lights.

**OFF** - The dome lights will not turn on in this position.

**AUTO** - Automatically switches on the dome lights in conjunction with the vehicle's interior illumination.

**10. Ventilation Openings**

**11. LCD Cut Off Switch**

Used to turn off the LCD monitor when in the closed position.

**12. LCD Panel**

**13. Screen Release.**

Press to release the screen.

**CONTROL FUNCTION DESCRIPTION  
(BACK VIEW)**

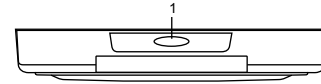

**1. REAR IR SENSOR**

Transmits audio to wireless headphones, allows the remote control to operate the ADV38FR and to control other Accessories in the system.

**CONTROL FUNCTION DESCRIPTION  
(SIDE VIEW)**

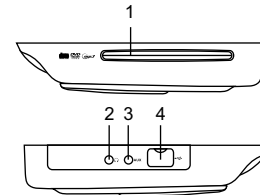

**1. DVD Disc Insertion Slot**

For loading and removing discs. Unit will turn ON and load disc when disc is inserted. Insert disc with label side facing up.

*Note: Disc slot will be lit when unit is turned OFF for easy loading at night.*

**2. HEADPHONE JACK**

Allows the use of wired headphone with a 1/8" (3.5mm) plug for listening to the audio output

**3. AUX IN**

The Jack is used for audio and video input.

**4. USB INPUT FOR USB MEMORY DEVICE**

Allows for the connection of an USB or memory device..

## TURNING THE UNIT ON OR OFF

1. Pushing in the Screen Release button will unlock the LCD screen and it will drop down slightly. Pivot the screen downward until a comfortable viewing angle is reached. The hinge friction will hold the screen in position while the system is in use.
2. Pressing the power button\* on the unit or the remote control will turn the system on and off. When in use the internal backlighting will illuminate the controls.
3. After the unit has been turned on and is displaying a picture, adjust the viewing angle, by pivoting the screen to optimize the picture quality.
4. Remember to turn the unit off and pivot the LCD to the locked position when not in use.

**\*Note:** Unit will turn On automatically when a Disc is inserted

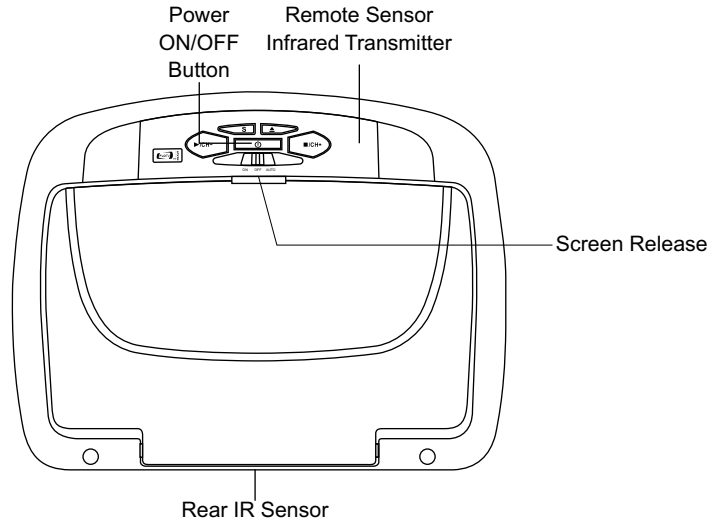

## **OVERHEAD DOME LIGHTS**

The Dome Lights integrated into the unit are controlled by a three position slide switch. Sliding the switch to the ON position will turn the lights ON. The OFF position will prevent the lights from turning ON with the vehicle's interior lighting and the auto position will allow the lights to turn ON and OFF with the vehicle's interior lighting. Refer to the Installation Guide for wire connections. Do not leave the vehicle unattended with the dome light switch in the ON position, as this could result in a discharged battery.

## **REAR IR SENSOR**

The ADV38FR incorporates two infrared remote sensors to relay signals to the unit when the remote control is pointed at the remote sensor.

## **ACCESSORIES**

### **WIRELESS HEADPHONES**

The ADV38FR includes a built-in infrared transmitter for use with the supplied wireless headphones. The headphone volume is adjusted using the controls on each headset. Any number of wireless headphones may be used but they must be used within a line of sight from the transmitter, as infrared transmissions, like visible light travel only in a straight line. See the documentation accompanying your wireless headphones.

### **WIRED HEADPHONES (OPTIONAL)**

There is one 1/8" headphone jack on the unit that can be used with any standard wired stereo headphones with a 1/8" plug. This jack is controlled by the volume up/down buttons on the remote control.



## SOURCE FEATURE

### AV1

The AV1 input may be connected to a external video source, video game system, or other audio / video devices. To access the audio/video inputs, turn the unit on and press the S (source) button on the ADV38FR or the Source button on the remote control until "AV1" is displayed on the screen. Turn the video source component on with its power button or remote control and it is now ready to play the audio and video signals from the source connected .

**Note:** AV1 sources are available only if pre-installed during your video product installation.

### FLO TV

The ADV38FR is designed to function with FLO TV. This function control is available when the overhead unit is used with an optional plug in FLO TV Harness and FLO TV Module. Once the FLO TV Harness and FLO TV Module are connected press the source button until the screen displays FLO TV. For specific instructions refer to Appendix A ,FLO TV.

### AUX

The AUX input may be connected to an external video source, video game system, or other audio/video devices. To access the audio / video inputs, turn the unit on and press the S (source) button on the ADV38FR or the Source button on the remote control until "AUX" is displayed on the screen.

**Note:** The ADV38FR can be used with many currently available portable media players that have RCA output cables. Plug the RCA outputs of the portable media player into the RCA connectors on the A/V adapter cable supplied with your ADV38FR and plug the 3.5mm plug on the other end of the adapter into the into the AUX IN jack on the side of the ADV38FR.

Your portable media player may need a special adapter from the manufacturer to be able to play video on the ADV38FR. Check the owner's manual supplied with your portable media player to see if one is available.

### GAME

Press the units S (source) button until the screen displays GAMES.

The GAME selection is controlled by wireless game controller.

## USING THE WIRELESS GAME CONTROLLER

The Game Controller transmits to the ADV38FR with two infrared transmitters located on the front of the Game Controller.

The Game Controller must be pointed toward the unit for correct operation.

Press the source button on the remote control or the unit until

## GAME CONTROLLER FUNCTIONAL DESCRIPTION

1. Install two AAA batteries in the Game Controller. Observe the correct polarity.
2. Use the ON/OFF selector switch to turn on the Game Controller. A list of ten games will be displayed.
3. Use the A button (page up) or B button (page down) to display the three pages of games (1-10, 11-20, 21-30). Then use the direction buttons to move the arrow to the desired game. Press Start to select the game.
4. Press Start to begin the game. Press Start again at any time to pause the game.
5. Press RESET to return to the game list.
6. Use the ON/OFF selector switch to turn off the Game Controller after use.

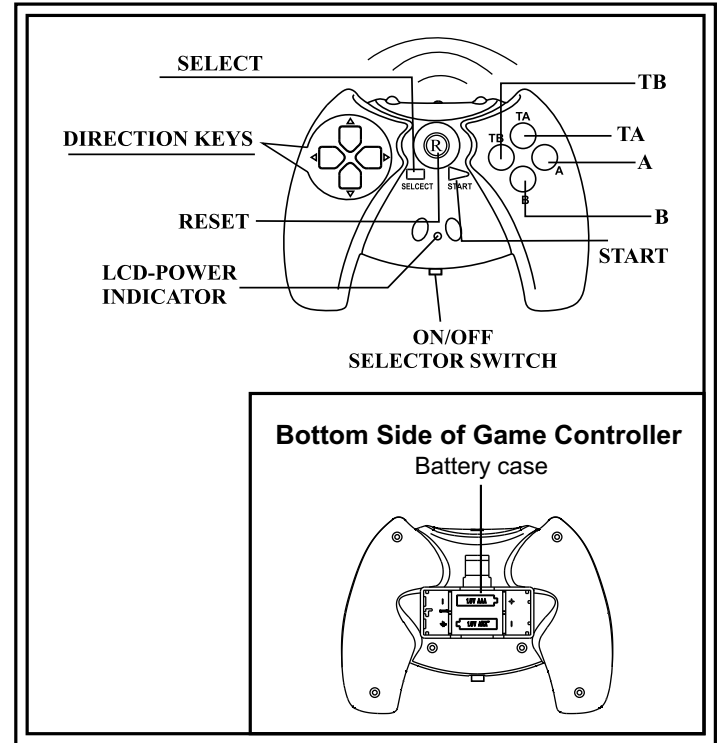

## REMOTE CONTROL OPERATION

Back View

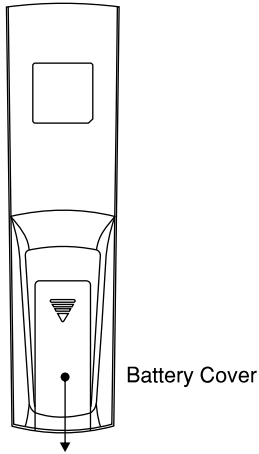

### Battery Installation

Before attempting to operate your Remote Control, install the batteries as described below.

- 1) Turn the Remote Control face down. Using your finger, slide the battery cover off in the direction of the arrow.
- 2) Install Two "AAA" batteries. Make sure that proper polarity (+ or -) is observed.
- 3) Align the cover tabs with the remote control and slide the cover until it locks.

The remote control will operate the ADV38FR. It is not a universal remote control and will not control equipment from other manufacturers.

## MAIN FUNCTION OPERATION

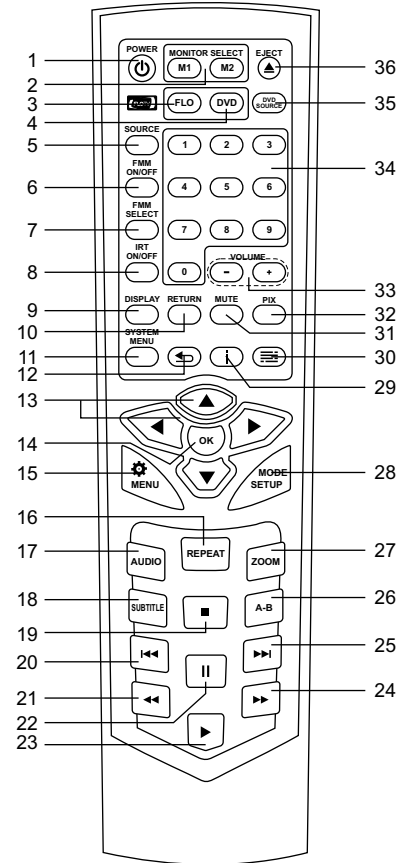

- \* Function control is available on the unit and the Remote Control.
- \*\* Function not available in this model.
- \*\*\* FLO TV function only available when optional FLO TV module is installed.

**Note:** Refer to Appendix A FLO TV for FLO TV operating instructions..

**1. POWER Button\***

Press this button to turn the unit ON and OFF.

**2. MONITOR SELECT Button**

**M1 Button** – Sets the remote control code to allow control of the unit set to M1 mode.

**M2 Button\*\*** – Sets the remote control code to allow control of the unit set to M2 mode.

**3. FLO TV Button \*\*\***

Press this button to access the FLO TV mode. Also switches the function keys on the remote control to correspond to FLO TV functions.

**4. DVD Mode Select Button**

Press this button when playing DVDs. Switches certain function keys on the remote control for DVD functions.

**5. SOURCE Button\***

Each time the button is pressed, the unit will select various sources in the following sequence:(DVD/USB, AV1/FLO TV, AUX and GAME).

**6. FMM ON/OFF Button**

Turns the FM Modulator on/off.

**7. FMM SELECT Button\***

Select the wireless FM Modulator Frequency:

(**CH1** 88.1MHz, **CH2** 88.3MHz, **CH3** 88.5MHz, **CH4** 88.7MHz, **CH5** 88.9MHz, **CH6** 89.1MHz, **CH7** 89.3MHz, **CH8** 89.5MHz, **CH9** 89.7MHz, **CH10** 89.9MHz, **CH11** 90.1MHz, **CH12** 90.3MHz, **CH13** 90.5MHz, **CH14** 90.7MHz, **CH15** 90.9MHz, **CH16** 91.1MHz).

**8. IRT ON/OFF Button**

Turns the Infrared Transmitter ON or OFF for IR Wireless Headphones.

**9. DISPLAY Button**

Press to display the current disc information while the disc is playing. Press the cursor (▲▼) buttons to select the Title or Chapter. For Title/Chapter selection use the numeric buttons to enter the desired Title Chapter selection.

**10. RETURN Button**

Press for the disc root menu. Press the button again to resume to disc playback.

**11. SYSTEM MENU Button**

Allow the user to access the system menu. Press cursor (▲▼) buttons to select desired screen mode, FMM frequency, OSD language and source default during power up.

**12. BACK Button \*\*\***

When in FLO TV mode takes the user back one screen when in the Menu, Show Information, Show Description, or Guide. Path ends at full screen TV.

**13. CURSOR Button (▲▼◀▶) \*\*\***

Use these buttons to access menu selections on the screen in DVD mode. Use these buttons for channel changing (up/down), navigating menus and selecting items in FLO TV mode.

**14. OK Button (ENTER)\***

Used to implement a selected setting or menu option.

## 15. MENU / SETTINGS Button

### a.) MENU Button

Pressing the MENU button in DVD mode will cause the DVD root menu to be displayed. When using the USB device, pressing the MENU button will cause the root menu to be displayed. Pressing the MENU button while listening to MP3 files has no effect as the operation is prohibited.

**Note:** Pressing the FLO TV button will access the FLO TV mode and disable the DVD and USB functions. To return to Dvd control functions press the DVD button..

### b.) SETTINGS Button (⚙️) \*\*\*

When in FLO TV mode the Settings button allows user to toggle the FLO TV settings menu on/off.

## 16. REPEAT Button

Allows the user to repeat a selected title, chapter, or track.

## 17. AUDIO Button

Press to display and select Audio language in DVD mode. Each time you press the button, the language changes.

**Note:** The available languages vary from disc to disc.

## 18. SUBTITLE Button

Press to display and select the subtitle language in DVD mode. Each time you press the button, the subtitle language changes.

**Note:** The type and number of languages for subtitle vary from disc to disc.

## 19. STOP Button (■)\*

Press the STOP button once to stop playback. (Playback will resume from the point it is stopped).

Press the STOP button twice to stop playback. (Playback will resume from the beginning of the disc).

## 20. PREVIOUS Button (⏮)

Press to return to the previous chapter or track.

## 21. SCAN BACKWARD Button (⏪)

Press to search in a backward direction. Press repeatedly to change the search speed from 2, 4, 8, 16 times the normal speed.

## 22. PAUSE Button (II)

Press to pause playback. Pressing the PAUSE button again or pressing the PLAY Button will resume normal playback.

## 23. PLAY Button\*

Press to activate the play mode while a disc is loaded in the disc compartment.

## 24. SCAN FORWARD Button (▶▶)

Press to search in a forward direction. Press repeatedly to change the search Speed from 2, 4, 8, 16 times the normal speed.

## 25. NEXT Button (▶▶)

Press to skip to the next chapter or track.

## 26. A-B Button

Allow user to repeat disc playback from point A to point B.

### Press A-B button

Once

Twice

3 Times

### On-Screen Display

Repeat A-

Repeat A-B

AB Off

### DVD Player

Mark the beginning of the section to repeat (Set point A)

Mark the end of the section to repeat (Set point B)

Cancel the A-B repeat function

## 27. ZOOM Button

Press this button to enlarge the picture when playing a DVD disc.

### Press ZOOM button

Once

Twice

3 times

4 times

### DVD player perform

Enlarge the picture 2 times of the original size

Enlarge the picture 3 times of the original size

Enlarge the picture 4 times of the original size

Picture is returned to original size

## 28. **MODE\* / SETUP Button**

### a.) **MODE Button \***

When in FLO TV mode pressing the MODE button toggles between FLO TV and an auxiliary A/V source attached to the FLO TV module. (**NOTE: your system may not have an auxiliary source**).

### b.) **SETUP Button**

When in DVD mode pressing the SETUP button will display the Setup Menu which allows the user to change the DVD player options such as OSD Language, Video, Rating etc. Refer to the settings and adjustment section for more information.

## 29. **INFORMATION Button ( ) \*\*\***

Pressing this button displays the Channel Info bar and the Program Description. When in FLO TV mode pressing the button opens the Channel Info bar. The second button press while Channel Info bar is displayed will provide program information. To return to the FLO TV program press the button again.

## 30. **CHANNEL GUIDE Button ( )\*\*\***

When in FLO TV mode pressing this button allows the user to turn the Channel Guide on and off. The Channel Guide opens with the current channel and show title highlighted.

## 31. **MUTE Button**

Press this button to mute the audio for wireless FMM, IR headphones and wired headphones.  
Pressing the button again restores the sound to the previously set level.

## 32. **PIX Button (Picture Select)Button**

Each time this button is pressed, the on screen picture adjustment displays the “adjustment bar” for BRIGHTNESS, CONTRAST, COLOR, TINT or RESET. Once the desired adjustment bar is displayed, use the VOLUME (+) / VOLUME (-) button to adjust the setting. The display will automatically turn off if no adjustments are made within 6 seconds.

## 33. **VOLUME DOWN (-) or UP (+) Button**

Press to decrease or increase the volume of the wired headphones. Press to decrease or increase the level of the picture settings. The settings are available after the picture select button is pressed.



**34. NUMBER Buttons**

When DVD mode these buttons allow the user to enter numbers 0 to 9 for selection of selection of CD tracks, DVD chapters and password. When FLO TV mode these buttons allow the user to select favorite channels and for PIN entry for parental controls. \*\*\*

**35. DVD Source Button**

This button is only active when remote control is in DVD mode. Each time the button is pressed one of the sources (DVD or USB) will be selected. If the USB is not plugged in, the unit it will remain on DVD Source. Plug in a USB memory device and press to change source from DVD to USB.

**36. EJECT (▲)\***

This button is used to eject the disc.

## MENU ADJUSTMENT

The System Menu Contains features and options that let you customize your system to change the screen mode display, OSD language and source default.

- 1) Press the SYSTEM MENU button on the remote, the main page of the system menu will appear on screen.
- 2) Use the cursor buttons ▲ or ▼ to select the desired item in the main page and press the ENTER button to select.
- 3) The sub menu will appear on screen.
- 4) Use the cursor buttons ▲ or ▼ to select an item in the sub menu and then press the ENTER button to select.
- 5) Press the System Menu button to exit System Menu.

**Note:** System Menu can be controlled via Remote Control only. (Items selected in the menu will have a green background)

### PICTURE CONTROL SELECT

When watching program, the picture quality can be adjusted to suit individual preferences.

- 1) Each time this button is pressed, the on screen picture adjustment displays the “adjustment bar ” for **BRIGHTNESS, CONTRAST, COLOR, TINT** or **RESET**.
- 2) Once the desired adjustment bar is displayed, use the Volume (+) / Volume (-) button to adjust the setting. The display will automatically turn off if no adjustments are made within 6 seconds, or is any other button is pressed.
- 3) Press the ▼ button four times to select RESET, then press either Volume (-) or the Volume (+) button on the remote or the main unit. All of the picture settings (**BRIGHTNESS, CONTRAST, COLOR** and **TINT**) will return to the factory setting.

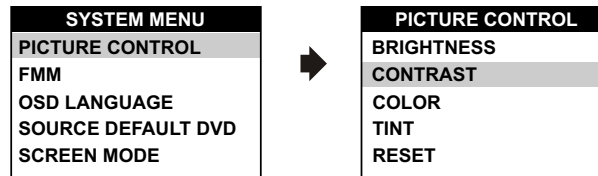

## **FMM SELECT**

FMM ON/OFF options - Turns the FM Modulator on or off.

FMM SELECT option - Selects the wireless FM Modulator Frequency (CH1 88.1MHz, CH2 88.3MHz, CH3 88.5MHz, CH4 88.7MHz, CH5 88.9MHz, CH6 89.1MHz, CH7 89.3MHz, CH8 89.5MHz, CH9 89.7MHz, CH10 89.9MHz, CH11 90.1MHz, CH12 90.3MHz, CH13 90.5MHz, CH14 90.7MHz, Ch15 90.9MHz, CH16 91.1MHz)

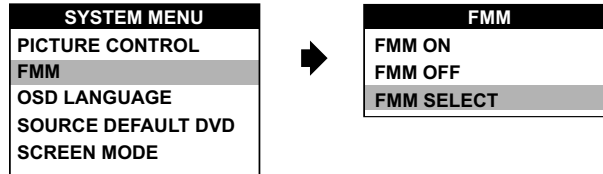

## **OSD LANGUAGE**

This allows the user to select the language for the on-screen display.

The user can either select English, Spanish, French, German for the OSD language.

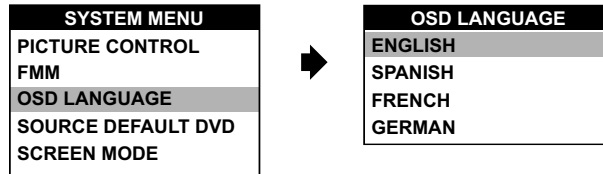

## **SOURCE DEFAULT DVD**

This allows the user to set the system default source to DVD (via System Menu).

### **Note:**

- If selected default source is set to DVD every time the unit's power is cycled with the source set to something other than DVD, the unit will power up and automatically switch the source over to DVD.
- Unit will be set to Last Memory on as the default mode of operation.
- Selection of Source default can only be made from within the system menu.

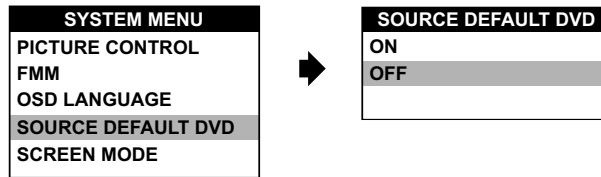

## **SCREEN MODE SELECT**

This allows the user to change the screen format (aspect ratio 4:3, 16:9).

To select the screen aspect ratio format, highlight SCREEN MODE and press the ENTER button to access the submenu. Then press the Up or down cursor buttons (▲ or ▼) to select from 4:3 or 16:9. Press ENTER button to confirm the setting.

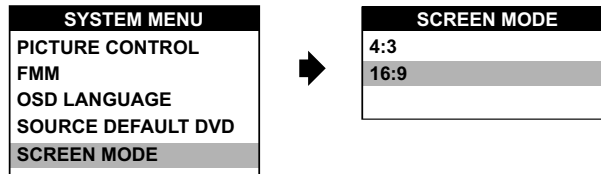

## SETTINGS AND ADJUSTMENTS

The Setup Menu contains features and options that let you customize your DVD player. For example, you can set a language for the on-screen display or prevent DVD playback for children.

### Using the Setup Menu

1. Press the SETUP button on the remote. The Setup Menu appears on the screen as shown per diagram.
2. To set the desired option, move the highlight into the setup area using the cursor button ►.
3. After entering the setup area, highlight the desired option using the cursor button ▲ or ▼.
4. Press ► to open the sub menu that contains the different options available. Press ▲ or ▼ to highlight the desired option, and press ENTER to confirm the selection.
5. Repeat steps 3~4 to set the options that reside on the same Setup Page.
6. To change to another Setup page, press ◀ to position the highlight back on the icon side of the Setup Page. Then, repeat steps 2~5.

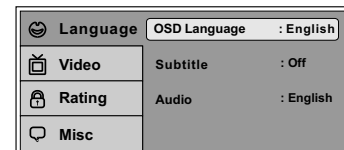

### Exiting the Setup Menu

Press the SETUP button again.

## LANGUAGE SETUP

### Language for On-Screen Display

OSD MENU: The OSD MENU setup allows you to select the language for the on-screen display. The user can either select English, French, Spanish, German or Italian for the OSD language.

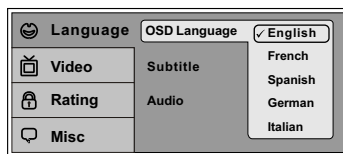

## SUBTITLE SETUP

Select "SUBTITLE" using ▲▼ button, then press ► button to enter the Sub menu. Select the subtitle you desire using ▲▼ button, then press "ENTER" to confirm the setting. Press ◀ button to return.

*Note: The subtitle selection is only available for discs that are recorded in the above listed languages. If the selected, language is not available, the player will play and display on the screen the original language contained in the disc.*

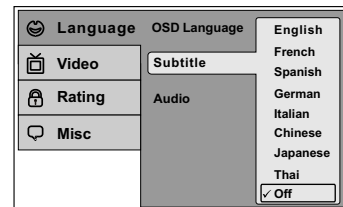

## AUDIO SETUP

Select "AUDIO" using ▲▼ button, then press ► button to enter the Sub menu. Select the audio you desire using ▲▼ button, then press "ENTER" to confirm the setting. Press ◀ button to return.

*Note: The audio selection is only available for discs that are recorded in the above listed languages. If the selected, language is not available, the player will play and display on the screen the original language contained in the disc.*

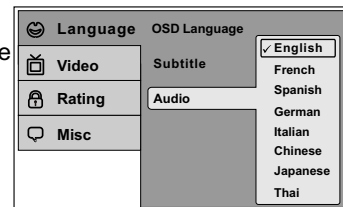

## VIDEO SETUP

### TV Display

The TV DISPLAY setup allows you to set the screen aspect ratio.

4:3

This displays the wide picture with black bands on the upper and lower portions of the screen.

16:9

This displays a wide picture with black bands on the upper and lower portion of the screen.

The bandwidth will vary, depending on the aspect ratio of the disc.

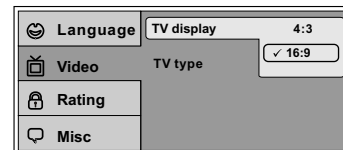

### TV Type

The TV Type setup allows you to select the system to fit to the color system of the TV to be connected.

NTSC - Select this type for NTSC TV

PAL - Select this type for PAL TV

MULTI - Select this type for multi-system TV

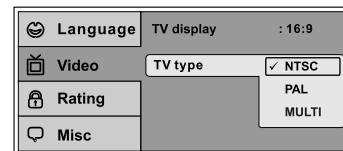

## RATING SETUP

### Rating

This item allows you to limit the content of movie playback from G to Adult. The lower the value, the more strict the control.

1. G
2. PG
3. PG – 13
4. R
5. NC – 17
6. Adult

The rating level can only be changed when the correct password is entered. The first time the parental control is entered, use the cursor ► button to enter parental mode, key in the default password (3308) and press ENTER. Press the ENTER button again to open the parental level sub menu. Select the desired level and press ENTER. To change the password to your own password highlight “Change Password” and press ENTER. Enter the default password (3308) and press ENTER. Press the ENTER button again and key in a new four digit password. Press ENTER button to end the process.

**Note:** The Default Password is 3308. This password is always accepted even after a new password has been entered. To avoid the possibility of others using the default password to set the parental level and change the password, record this default password in another area and delete it from this manual. The restriction of viewing disc content by younger users may be available on some disc but not on others.

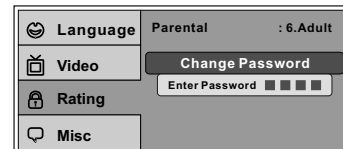
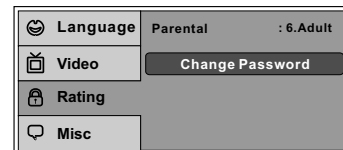

### Misc SETUP

Select "MISC" using ▲▼ button, then press ► button to enter the Misc menu.

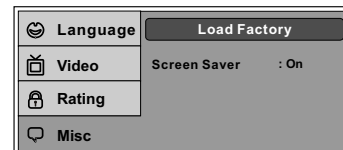

## Load Factory

This option allows you to reset all options to factory settings.

*Note: This function will not affect the Rating control settings.*

## Screen Saver

This option allows the operator to set the Screen saver mode.

ON -Screen saver will appear

OFF -Screen saver will not appear

*Note: The DVD player will enter Screen Saver mode if the unit is inactive for approximately 2 minutes.*

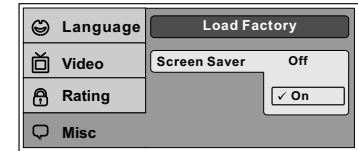
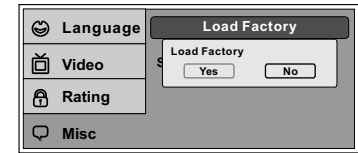

## Playing DVDs

1. Press the DISPLAY button on the remote control to display the status banner. The banner includes title, chapter, angle, audio, subtitle and time.
2. **Title Selection**  
Press numeric (0~9) buttons to initiate a change of title selection. Then press ENTER to implement the selection.
3. **Chapter selection**  
Press numeric (0~9) buttons to initiate a change of chapter selection. Then press ENTER to implement the selection.

## USB Memory Devices

1. The System will detect the insertion of the USB device automatically if no disc is loaded. The system only auto detects the first media inserted (USB drive); the second media source can be manually selected by pressing the DVD source button on the remote control when the unit is in DVD mode.
2. When a disc is inserted, the system will switch to DVD mode immediately regardless of a USB media is currently playing.
3. The DVD source (DVD or USB) can only be changed if the DVD is stopped.
4. This system cannot support more than 2 memory partitions on the USB thumb drive.

**Note:** *The system will always default to the DVD when the system detects a disc in the DVD player.*



## Playing MP3 Discs

MP3 is a format for storing digital audio. An audio CD-quality song can be compressed into the MP3 format with very little loss of quality, while taking up much less space. CD-R discs that have been encoded in MP3 format can be played on DVD player. The DVD player plays the songs in the order they were burned on to the disc. When playback is started the elapsed time of the track that is playing will be displayed.

## Selecting Folders and Songs

When a device containing MP3 files is loaded in the player, the navigation menu appears automatically.

1. Press ▲ or ▼ to move the highlight to the desired folder (if present) on the left side of the menu and press ENTER. The songs in the folder will be displayed on screen.
2. Press ▲ or ▼ to move the highlight to the desired track containing the song and press ENTER to begin track playback.

## Skipping Songs

Use the Next (▶▶) button on the remote control to move to the next song. Use the Previous (◀◀) button to move to the previous song.

## Selecting a Play Mode

### Filter (For MP3 & JPEG only)

Filter Mode enables or disables the display of files contained on the media based on their file extension.

The filter function applies to the following formats:

- Audio** - Audio data format (MP3, WMA)
- Photo** - Photo data format (JPEG)
- Video** - Video data format (MPEG I, II)

### Flat Mode: play the entire disc

This mode is always on (default). During the Flat Mode, all the data folder with MP3, JPEG and movies will be played in sequence. If the Flat Mode function is off, it will only play the selected folder; other folders are disabled.

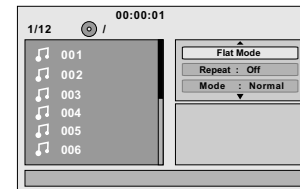

## Repeat: play repetitively

Repeat function has 4 options : Off, Single, Folder, All. Move cursor to Repeat function and press ENTER, Each time ENTER is pressed the unit will cycle through the available options. Off/Single/Folder/All are displayed in that order. Repeat default is Off;

- Off** Turn off repeat function
- Single** Repeat the song being played until STOP is pressed.
- Folder** Play all songs in a folder repetitively
- All** Play all songs on the disc repetitively

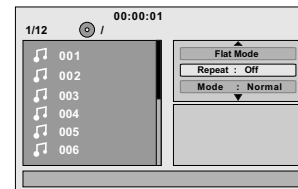

## Mode: play mode

The Mode function has 4 options: Normal, Shuffle, Random and Music Intro. Move cursor to the Mode function area and press ENTER repeatedly till the desired mode is displayed. Normal/Shuffle/Random/Music Intro are displayed in that order. The Mode function default is Normal.

**Normal:** Play all songs in folder once.

**Shuffle:** Play songs in a folder in a shuffle order. Each song in the folder is played only once.

**Random:** Play songs in a folder in a random order. Each song in a folder is't only be played once.

**Music Intro:** Play each song in order in the folder for 10 seconds The purpose of the Music Intro function is to provide the user with a sample of each song for 10 seconds, thereby making it easy to select and listen to a favorite song.



## Add to program

**Method:** To add the selected songs into Browser view, make sure disc playback is off. Move cursor to “Edit Mode” function and press ENTER. After “Edit Mode” is selected, move cursor to songs list and select the songs which will be compiled and press ENTER. A check mark appears to the left of the selected song; to add the selected songs to the program, move cursor to the “Add to Program” function and press ENTER. The selected songs is added into a new program list and the check mark will disappear on play list, move cursor to “Program View” function and press ENTER to browse the songs in the program. Press play button to play the selected songs.

**Note:** Edit Mode, Program View or Add to Program functions are relationship related when selecting the preferred song add to the songs

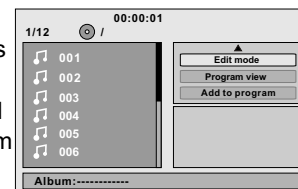

## Clear program

**Method:** To clear the selected song files, press the STOP button twice during playback mode. Move the cursor to the “Edit Mode” function and press ENTER. After “Edit Mode” is selected, move cursor to selected songs list and select the songs you want to delete. Press ENTER and a check mark will appear to the left of the selected song. Move the cursor to clear program and press ENTER, the selected songs will be deleted from the play list.

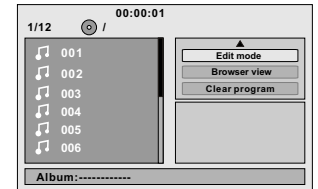

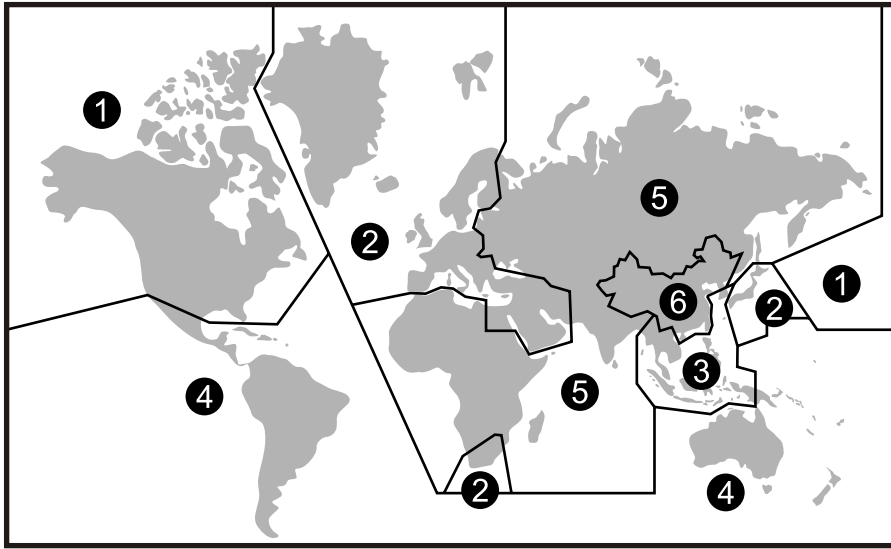

Region 1- USA, Canada

Region 2- Japan, Europe, South Africa, Middle East, Greenland

Region 3- S. Korea, Taiwan, Hong Kong, Parts of South East Asia

Region 4- Australia, New Zealand, Latin America (including Mexico)

Region 5- Eastern Europe, Russia, India, Africa

Region 6- China

### **DVD Region Code**

The DVD player is preset to a region code at the factory depending on where the DVD player is sold. DVDs from a different region cannot be played in this unit and the unit will display "WRONG REGION"

### **DVD Basics**

To get the optimum use out of the DVD section, make sure you read this section completely.

### **Types of Discs your DVD will play**

- DVD\* disc - DVD discs which contain video.
  - Audio discs - Audio CDs contain musical or sound content only.
  - MP3 discs - A disc that contains audio files (for example, a CD-R with downloaded MP3 files).
- \* This system is capable of playing most recordable DVD formats. However, due to the variety of disc manufacturers and software, playback cannot be guaranteed.

### **Loading and Playing Discs**

Before you load a disc, make sure that it is compatible with the player. Insert the disc with the label facing the headliner of the vehicle.

**Note:** *the following Discs **CANNOT** be used with this player :*

- *MiniDisc*
- *Laserdisc*
- *CD-1, BD (Blu-ray Disc) CD-ROM, DVD-ROM, Super Audio CD (SACD), DVD Audio, JPEG.*

### **To load and Play a Disc**

Press the Power button to turn the unit ON. Select DVD mode and insert the disc (Label facing headliner) into the disc compartment.

## TROUBLESHOOTING

<b>PROBLEM</b>	<b>SOLUTION</b>
IR remote inoperative	<ul style="list-style-type: none"><li>• Verify that the batteries in the remote are fresh.</li><li>• Verify that the remote sensor eye is not obstructed.</li></ul>
Disc won't play	<ul style="list-style-type: none"><li>• Insert a disc with the label side facing up.</li><li>• Check the type of disc you put into disc tray. This DVD only plays DVDs, audio CDs and MP3s.</li><li>• Both the unit and the disc are coded by region. If the regional codes don't match, the disc can't be played.</li></ul>
Play starts, but then stops immediately	<ul style="list-style-type: none"><li>• The disc is dirty. Clean it.</li><li>• Condensation has formed. Allow player to dry out.</li></ul>
No sound or distorted sound	<ul style="list-style-type: none"><li>• Make sure your DVD is connected properly. Make sure all cables are securely inserted into the appropriate jacks.</li><li>• If you are using the 2-channel IR headphones, make sure you turn on the IR headphone power, make sure the correct channel (A-B) is selected.</li><li>• Make sure the Modulator is ON and the proper Frequency has been selected.</li><li>• Make sure that unit is set to M1 when using Single Channel Headphones.</li></ul>
Can't advance through a movie	<ul style="list-style-type: none"><li>• It can't advance through the opening credits and warning information that appear at the beginning of movies because the disc is programmed to prohibit that action.</li></ul>

## TROUBLESHOOTING (cont'd)

PROBLEM	SOLUTION
⊘ Not allowed at the moment	<ul style="list-style-type: none"><li>• The feature or action cannot be completed at this time because:<ol style="list-style-type: none"><li>1. The disc's software restricts it.</li><li>2. The disc's software doesn't support the feature (e.g., angles)</li><li>3. The feature is not available at the moment.</li><li>4. You have requested a title or chapter number that is out of range.</li></ol></li></ul>
Picture is distorted	<ul style="list-style-type: none"><li>• The disc might be damaged. Try another disc.</li><li>• It is normal for some distortion to appear during forward or reverse scan.</li></ul>
No forward or reverse scan	<ul style="list-style-type: none"><li>• Some discs have sections that prohibit rapid scanning or title and chapter skip.</li><li>• If you try to skip through the warning information and credits at the beginning of a movie, you won't be able to. This part of the movie is often programmed to prohibit skipping through it.</li></ul>
FLO TV not functioning	See Troubleshooting Guide at the end of Appendix A.

Technical Support 1-800-645-4994

## REPLACEMENT PARTS

Remote Control	136-5055
Wireless Headphones	IR1CFF

## SPECIFICATIONS

LCD Backlighting	Edge Light Tube
Resolution	1280 (RGB) x 800
Pixels	3,072,000
Operation Temperature	32 ~131 F (0 ~ 55° C)
Storage Temperature	-4 ~ 158 F (-20 ~ 70° C)
Backlit life	30,000 Hours
Video Display System	NTSC / PAL
Headphone Audio Output	0.03W @ 32 ohms
Video Output	1.0Vp-p @ 75 ohms
Power Source	12V DC
Dimension	L x W x H
	14.0" x 12.0" x 2.0"
	356mm x 305mm x 51mm

Specifications are subject to change without prior notice.



## APPENDIX A FLO TV

---

### Copyrights and Trademarks

© 2009 Audiovox Corporation. All rights reserved.

FLO, FLO TV and the FLO TV logo are trademarks of QUALCOMM Incorporated.

QUALCOMM is a registered trademark of QUALCOMM Incorporated in the United States and may be registered in other countries.

AUDIOVOX is a registered trademark of Audiovox Corporation.

ADVENT is a registered trademark of Audiovox Corporation.

MACROVISION is a registered trademark of ROVI Corporation.

### Technical Information

The *FLO TV*™ service operates on UHF channel 55 (720 MHz) and is multicast from terrestrial towers. Coverage will vary and reception is dependent upon the FLO TV module in your vehicle being within range of the towers. Coverage area can be viewed on the FLO TV web site ([www.flotv.com](http://www.flotv.com)).

The FLO (Forward Link Only) TV service is transmitted over the *FLO TV*™ network and received by the FLO TV module in your vehicle. Along with the television program material, data is transmitted for the program guide and is updated on a regular basis. If you are out of the coverage area the program guide will be updated when the vehicle returns to the coverage area.

This product incorporates copyright protection technology that is protected by U.S. patents and other intellectual property rights. Use of this copyright protection technology must be authorized by Macrovision, and is intended for home and other limited viewing uses only unless otherwise authorized by Macrovision. Reverse engineering or disassembly is prohibited.

## **FLO TV OPTION (P/N ADVFRK1)**

Your ADV38FR is designed for adding an optional FLO TV Tuner. If you do not have the FLO TV Tuner installed, this section can be ignored. To have the FLO TV Tuner added to your system contact the business that installed your ADV38FR.

### **Activation/Subscription Information**

Your FLO TV module will need to be activated before you can begin enjoying the *FLO TV* service. Activation takes place after you subscribe to the *FLO TV service*.

To activate the FLO TV module, call 1-888-99FLOTV (1-888-993-5688). You may also activate on line at [www.flotv.com](http://www.flotv.com). You must be over the age of 13 to activate your subscription.

You will need the following information before you can activate your subscription:

1. Activation Instructions Card
2. Device ID Number
3. Authorization Code
4. A valid credit card AMEX/MC/VISA (have your credit card information ready when you call) Note: The credit card will be used to verify your account and will not be charged if service was included with your product purchase.
5. An active email address
6. Billing information (Home/business address linked to your credit card)

To locate your Device ID and Authorization Code turn on the overhead video display in your vehicle and set the source to FLO TV. Press the FLO TV button on the remote control view FLO TV. Press the  (Settings) key on the remote to access the Settings Menu. Press the ▼ (down arrow) key to highlight Subscription Information and press the ENTER key on the remote. Your Device ID and Authorization Code will be displayed on the overhead screen. Write these numbers down before calling FLO TV.

The FLO TV module is activated over the air and your vehicle must be within the coverage area and running. Keep the vehicle on and powered for about ten minutes after you have activated the unit with *FLO TV Services* for the activation to take place. Test your FLO TV to make sure that you are subscribed and all channels work prior to shutting off the vehicle.

## **FLO TV Introduction**

Please refer to the following as an overview to use the FLO TV *service*:

1. Turn the vehicle ignition key to the ON position. Turn on your ADV38FR and select the FLO TV source by pressing the Source button on the overhead or by pressing the FLOTV Button on the remote. (Note: Watching the *FLO TV* service for an extended period of time with the engine OFF will run down the vehicle's battery.)
2. The ADV38FR screen will show the FLO TV splash screen which will appear for about 30 seconds and then the FLO TV preview channel or the last channel that was being viewed.
3. Press the ▲ (up arrow) or ▼ (down arrow) key on the remote to change channels.
4. Press the ≡ (Guide) key on the remote to access the FLO TV Channel Guide.
5. The arrow keys (▲▼◀▶) on the remote allow for navigation through the Channel Guide.
6. Press the ENTER key on the remote to select a desired channel/show from the Channel Guide.
7. Press the ⓘ (Information) key on the remote to display the program information related to the current program.
8. Press the ⚙ (Settings) key on the remote to access the FLO TV user settings menu (e.g. Parental Control, etc.).
9. The Mode key on the remote allows the user to switch between the *FLO TV* service and an auxiliary A/V source if one is connected.
10. Visit [www.flotv.com](http://www.flotv.com) for more info.

## FLO TV Operation

You can operate the FLO TV module with the wireless remote control.

When FLO TV is powered on, the FLO TV logo screen will be displayed until the receiver tunes to a channel. This may take up to 30 seconds after the vehicle and overhead turned on.

Upon power up, the *FLO TV* service will default back to the last viewed channel. If the screen does not appear press the Mode key on the remote control to switch back to FLO TV.



## Are You Subscribed?

If you are not subscribed to FLO TV a Preview Channel will be displayed. Changing to another channel will display a screen similar to the adjacent one. (Note: Screen background in this example has diagonal bars in it)

Some channels may not be available for viewing if they are not included in the *FLO TV* service package you are subscribed to.



## Are You Covered?

*FLO TV* service coverage is available in many metropolitan areas and travel corridors within the United States. Please visit the *FLO TV* web site ([www.flotv.com](http://www.flotv.com)) to check the coverage maps in your area.

If you are travelling in an area that is not covered by the *FLO TV* network or travel out of the areas covered by the *FLO TV* network the adjacent screen will be displayed:

Once you have returned to an area covered by the *FLO TV* network, *FLO TV* programming will resume. If you are planning a trip, check the *FLO TV* web site ([www.flotv.com](http://www.flotv.com)) to see if your route is within the *FLO TV* network coverage area.

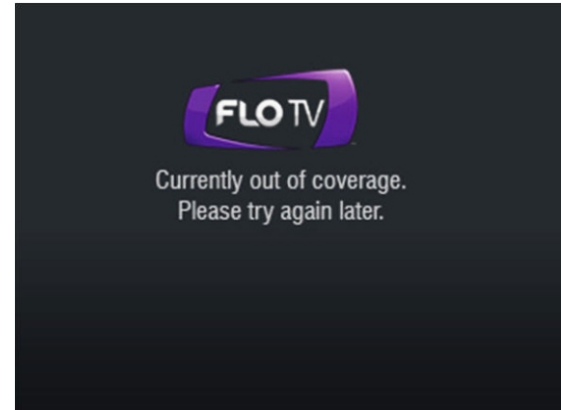

## Remote Control Functions

### Function

Use for channel changing (up/down), navigating menus, and selecting items

### Symbol



Use to select a channel or setting

**OK (ENTER)**

Information key - use to display program information.



Channel Guide - use to select the channel guide



Back key - takes the user back one screen when in the Menu, Show Information, Show Description, or Guide. Path ends at full screen TV



Number keys - use to select favorite channels and for PIN entry for parental controls

1,2,3,4,5,6,7,8,9,0

Settings key - allows the viewer to toggle on/off the FLO TV settings menu



Mode key - toggles between FLO TV and an auxiliary A/V source (Note: Your system may not have an auxiliary source)

**MODE**

## How is FLO TV Programming Rated?

Parental controls are built into FLO TV so that you can filter the program and movie content that can be watched on the *FLO TV* service. Adjacent is a ratings chart based on content type for TV program material and movie material:

Movie ratings information, if provided, is available in the FLO TV programming guide. Audio content can be restricted as well based on the adjacent chart:

### Notes

- o Unrated content (NR) does not have a rating exposed in the user interface, and the rating string value will be blank when this occurs.
- o FLO TV blocks or allows unrated programs based on whether the unrated program is allowed to play with Parental Controls enabled.
- o Specific programs identified as most restrictive must challenge the user to enter the PIN, even if parental controls are turned on at the least restrictive level.
- o Specific programs identified as least restrictive must NOT challenge the user to enter the PIN, even if parental controls are turned on at the most restrictive setting.
- o If the correct PIN is entered, the restrictive content can be displayed.

TV Ratings
TV-Y
TV-Y7
TV-G
TV-PG
TV-14
TV-MA

Audiocast Ratings
Clean
Explicit

## Getting Around in FLO TV

Watching the *FLO TV* service limits the channel information or pop-ups occurring while viewing the program as shown on the adjacent screen:



If you want to see what channel you are on, press the ⓘ (Info) key and the adjacent screen and information will appear:

- Channel Logo
- Program Title
- Program Start Time
- Program End Time
- Program rating





Pressing the ⓘ (Info) key again will display more information about the channel being viewed as shown in the adjacent screen:

Information displayed:

- o Channel Logo
- o Program Title
- o Program Start Time
- o Program End Time
- o Program Rating
- o Episode Title
- o Episode Summary

Pressing the ⓘ (Info) key will return the viewer to the full screen.



## FLO TV Program Guide

You can access the FLO TV program guide by pressing the  (Guide) key which displays the program guide:

The FLO TV program guide is a matrix of programs and their start times, organized by channel. A user can view the guide and tune to a currently playing program or view program descriptions for future programs. The following information generally is displayed:

- o FLO TV Logo
- o Current Time
- o Current Day
- o Guide Day
- o Guide Time
- o Channel Logo
- o Program Title
- o Parental Block Icon (lock symbol)
- o More Icon ►

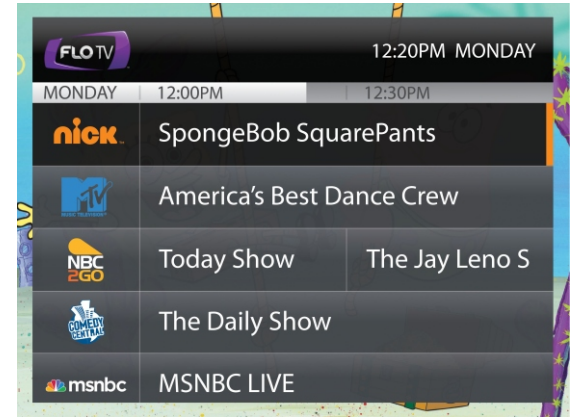

## Notes

- Programs that are blocked due to Parental Controls display the locked icon.
- The channel logo column is not selectable.
- The guide loops vertically when you press the ▲ (up arrow) or ▼ (down arrow) key.
- The guide is bounded horizontally by time. The user cannot navigate into the past or beyond the amount of guide data available.
- Current program tuned is designated by darker cell color and vertical right color bar when not in focus.
- Guide Day refers to the day within the guide data the user is currently viewing.
- Guide Time refers to the time within a particular day of guide data the user is currently viewing. These values change as the user scrolls right and left through guide data.
- Current Day and Current Time are independent of Guide Day and Guide Time.
- The More ► Icon is visible when a show's length extends beyond the bounds of the current guide view. They are visible when going forward in time and going back in time.

## Settings Menu

Press the ⚙️ (Settings) key to enter the Settings Menu and the adjacent screen will be displayed:



## Parental Controls

In the Settings Menu, the first selection is Parental Controls, which is highlighted in light gray. Press the ENTER key to access the parental controls menu. The adjacent following screen will be displayed:



Use the ► (right arrow) key to highlight the parental on/off control and press OK to enable it or disable it. Once enabled, press the OK key and you will be prompted to create a PIN (Personal Identification Number) as shown in the adjacent screen:

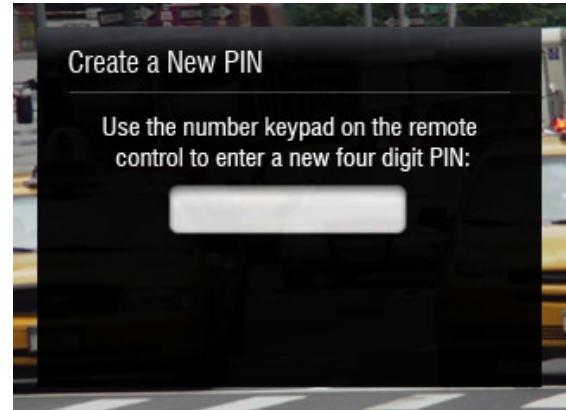

Use the remote control keypad to enter a 4 digit PIN. When the fourth digit is entered the adjacent screen will appear to confirm the new PIN.

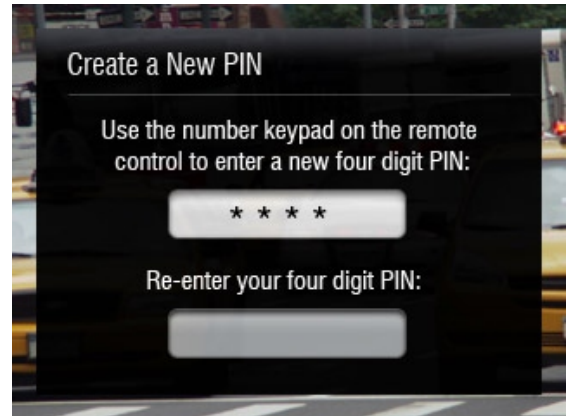

Re-enter the same 4 digit PIN to confirm the PIN number.  
The adjacent screen will be displayed:

(NOTE: Write the PIN down in a secure location. If it is lost you will have to call 1-888-99FLOTV to reset the PIN. The PIN cannot be reset online. Do not share your PIN with the person whose access to programming is being restricted.)

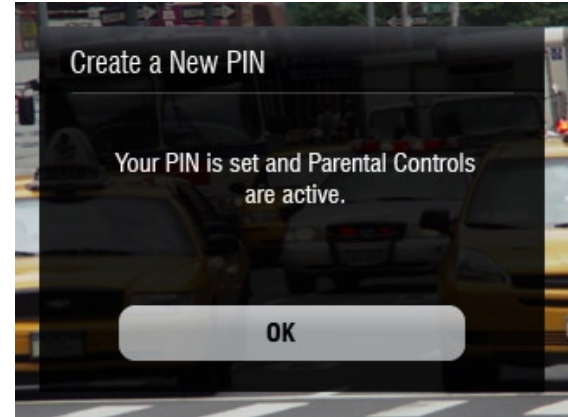

Once you have set your PIN, you can now change the ratings limit on TV, Movies and Audio content. To change the ratings:

Use the ▼ (down arrow) key to highlight TV Rating, Movie Rating or Audio Limit or Restricted Channels and press the OK key on the remote control. The adjacent screen will appear:

Use the ► (right arrow) and ◀ (left arrow) key to change the TV rating. Once you get to the rating you want, press the OK key to select it. Press the (Back) key to return to TV viewing.



## Favorite Channels

Up to 10 channels can be programmed into the numeric keys on the remote. Once they are programmed, pressing any one of them tunes your FLO TV to the channel that you have pre-programmed to the number key.

If you have not pre-programmed favorites, when you press a numeric key, you will be prompted by the info bar at the bottom of the screen asking you if you want to add the channel to your favorites:

To program favorite channels press the ⚙️ (Settings) key to access the settings menu. Use the ▼ (down arrow) key to highlight Favorite Channels and press the ENTER key.

The adjacent screen will appear which lists each channel available on the FLO TV service. Use the ▲ (up arrow) or ▼ (down arrow) key to highlight a channel and press a numeric key to set the highlighted channel to a favorite. In the example below, the Nickelodeon channel is set to the number 1 key.

Once you are back watching the FLO TV service you can press a number key to quickly access your favorite channels. Up to 10 channels can be programmed with the numeric keypad (0-9).



## Subscription Information

In the Settings Menu, use the ▲ (up arrow) or ▼ (down arrow) key to highlight Subscription Information and press the ENTER key, the adjacent screen will be displayed:

This screen tells you the basic information of your FLO TV system.  
(Note: The Authorization Code and Device ID will be different from the above screen, which is for reference only.)

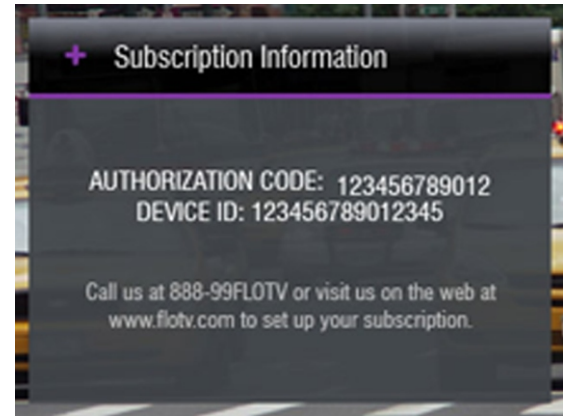

## System Information

In the Settings Menu, use the ▲ (up arrow) or ▼ (down arrow) key to highlight System Information and press the OK key, the adjacent screen will be displayed:

This screen tells you the signal strength of the FLO TV signal. If you are having reception problems, go to this page to see if the FLO TV signal is available at your location. (Note: The Device ID will be different from the adjust screen, which is for reference only.)





## Legal Information

Use the ▼ (down arrow) key to highlight Legal Information. This information governs the terms and conditions of your use of the *FLO TV* service and the *FLO TV* network. To see the full text and the privacy policy go to [www.flotv.com](http://www.flotv.com).

### Legal Information

#### TERMS AND CONDITIONS:

The documents that govern your use of the FLO TV™ service and the FLO TV software as well as how FLO TV Incorporated (FLO TV) uses, discloses and transfers data any time you interact with FLO TV, contact FLO TV or purchase or use FLO TV's products and services are set in these Terms and Conditions.

## Troubleshooting

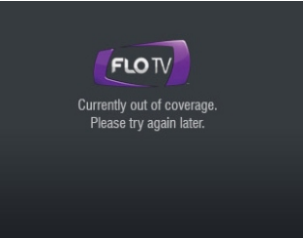
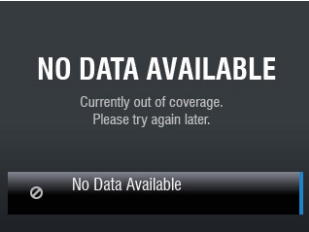
Explanation	FLO TV Screen Observed
<p>You are not subscribed and are not able to access any channel except the FLO TV channel.</p>	 <p>The image shows a black screen with the FLO TV logo at the top. Below the logo, the text reads: "You are not subscribed to this channel. Please call 888-99FLOTV or visit us at www.floTV.com to subscribe." At the bottom, it provides "Device ID: 123456789012345" and "Authorization Code: 123456789012".</p>
<p>Unable to access any channel; you are out of the coverage area.</p>	 <p>The image shows a black screen with the FLO TV logo at the top. Below the logo, the text reads: "Currently out of coverage. Please try again later."</p>
<p>You are either out of the coverage area or your FLO TV module has not updated the program guide information. The FLO TV Service will return to normal when you are back in the coverage area.</p>	 <p>The image shows a black screen with the text "NO DATA AVAILABLE" in large white letters at the top. Below it, it says "Currently out of coverage. Please try again later." At the bottom, there is a blue progress bar with a refresh icon and the text "No Data Available".</p>

## Troubleshooting (cont'd)

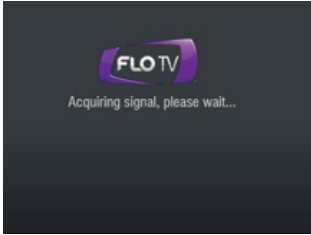
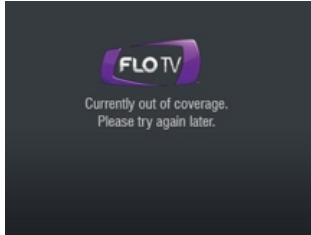
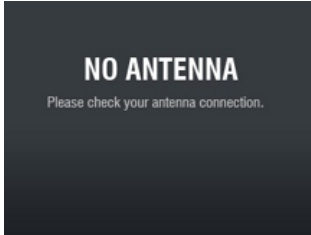
Explanation	FLO TV Screen Observed
<p>You are in a fringe coverage area; programming will return to normal when you are back in the coverage area..</p>	 A dark grey rectangular screen with the FLO TV logo at the top center. Below the logo, the text "Acquiring signal, please wait..." is displayed in a light grey font.
<p>You are out of the coverage area; programming will return to normal when you are back in the coverage area.</p>	 A dark grey rectangular screen with the FLO TV logo at the top center. Below the logo, the text "Currently out of coverage. Please try again later." is displayed in a light grey font.
<p>Contact the car dealer or the retailer where this product was installed or purchased.</p>	 A dark grey rectangular screen with the text "NO ANTENNA" in large, bold, white capital letters at the top center. Below it, the text "Please check your antenna connection." is displayed in a smaller, light grey font.

## Troubleshooting (cont'd)

<b>Problem</b>	<b>Root Cause</b>	<b>Solution</b>
<b>Poor or No Video</b>	<b>FLO TV Input not selected</b>	<b>Change the source inputs on the overhead until the FLO TV signal is displayed.</b>
<b>Wireless Remote Control does not work</b>	<b>Batteries installed incorrectly</b>	<b>Verify that the two AAA batteries are installed properly per the polarity markings.</b>
	<b>Batteries are dead</b>	<b>Replace the two AAA batteries.</b>

Customer Care – This number is for problems with FLO TV Service and is not for problems with the VOD108FR Call 1-888-99FLOTV (1-888-993-5688)



## ADVENT LIMITED WARRANTY

*Applies to ADVENT Mobile Video Products*



AUDIOVOX ELECTRONICS CORP. (the Company) warrants to the original retail purchaser of this product that, should this product or any part thereof (except game controllers), under normal use and conditions, be proven defective in material or workmanship within 36 months from the date of original purchase, such defect(s) will be repaired or replaced with reconditioned product (at the Company's option) without charge for parts and repair labor. If your new vehicle's radio, CD/DVD player is covered by the manufacturer's warranty for a period of 48 months as set forth in the OEM Warranty Booklet, the company will extend the Advent Mobile Video product warranty for the same period of time. This is not applicable to extended warranty purchases beyond the original manufacturer's warranty. A game controller, if supplied, is similarly warranted for ninety (90) days.

To obtain repair or replacement within the terms of this Warranty, the product is to be delivered with proof of warranty coverage (e.g. dated bill of sale), specification of defect(s), transportation prepaid, to the Company at the address shown below.

This Warranty does not extend to the elimination of externally generated static or noise, to correction of antenna problems, to costs incurred for installation, removal or reinstallation of the product, or to damage to digital memory/media devices, gaming devices, discs, speakers, accessories, or vehicle electrical systems.

This Warranty does not apply to any product or part thereof which, in the opinion of the Company, has suffered or been damaged through alteration, improper installation, mishandling, misuse, neglect, accident, or by removal or defacement of the factory serial number/bar code label(s). THE EXTENT OF THE COMPANY'S LIABILITY UNDER THIS WARRANTY IS LIMITED TO THE REPAIR OR REPLACEMENT PROVIDED ABOVE AND, IN NO EVENT, SHALL THE COMPANY'S LIABILITY EXCEED THE PURCHASE PRICE PAID BY PURCHASER FOR THE PRODUCT.

This Warranty is in lieu of all other express warranties or liabilities. ANY IMPLIED WARRANTIES, INCLUDING ANY IMPLIED WARRANTY OF MERCHANTABILITY, SHALL BE LIMITED TO THE DURATION OF THIS WRITTEN WARRANTY. ANY ACTION FOR BREACH OF ANY WARRANTY HEREUNDER INCLUDING ANY IMPLIED WARRANTY OF MERCHANTABILITY MUST BE BROUGHT WITHIN A PERIOD NOT EXCEEDING 12 MONTHS AFTER EXPIRATION OF THE WARRANTY. IN NO CASE SHALL THE COMPANY BE LIABLE FOR ANY CONSEQUENTIAL OR INCIDENTAL DAMAGES FOR BREACH OF THIS OR ANY OTHER WARRANTY. No person or representative is authorized to assume for the Company any liability other than expressed herein in connection with the sale of this product.

Some states do not allow limitations on how long an implied warranty lasts or the exclusion or limitation of incidental or consequential damage so the above limitations or exclusions may not apply to you. This Warranty gives you specific legal rights and you may also have other rights which vary from state to state.

## NOTES

## NOTES



For Customer Service  
Visit Our Website At  
**[www.mobile.audiovox.com](http://www.mobile.audiovox.com)**  
Product Information, Photos,  
FAQ's Owner's Manuals

---

---

---